



Product designation				Power contactor
Product type designation				BF32
Contact characteristics				
Number of poles	Nr.			3
Rated insulation voltage U _i IEC/EN	V			690
Rated impulse withstand voltage U _{imp}	kV			6
Operational frequency	min	Hz	25	
	max	Hz	400	
IEC Conventional free air thermal current I _{th}	A			56
Operational current I _e	AC-1 (=40°C)	A	56	
	AC-1 (=55°C)	A	45	
	AC-1 (=70°C)	A	40	
	AC-3 (=440V =55°C)	A	32	
	AC-4 (400V)	A	13.5	
Rated operational power AC-3 (T=55°C)	230V	kW	8.8	
	400V	kW	16	
	415V	kW	17	
	440V	kW	17	
	500V	kW	20	
	690V	kW	22	
Rated operational power AC-1 (T=40°C)	230V	kW	21	
	400V	kW	36	
	500V	kW	45	
	690V	kW	62	
IEC max current I _e in DC1 with L/R = 1ms with 1 poles in series	=24V	A	30	
	48V	A	26	
	75V	A	22	
	110V	A	8	
	220V	A	-	
IEC max current I _e in DC1 with L/R = 1ms with 2 poles in series	=24V	A	32	
	48V	A	32	
	75V	A	28	
	110V	A	25	
	220V	A	3	
IEC max current I _e in DC1 with L/R = 1ms with 3 poles in series	=24V	A	32	
	48V	A	32	
	75V	A	32	
	110V	A	27	

	220V	A	23
IEC max current I _e in DC1 with L/R = 1ms with 4 poles in series			
	=24V	A	–
	48V	A	–
	75V	A	–
	110V	A	–
	220V	A	–
IEC max current I _e in DC3-DC5 with L/R = 15ms with 1 poles in series			
	=24V	A	20
	48V	A	17
	75V	A	15
	110V	A	2,5
	220V	A	–
IEC max current I _e in DC3-DC5 with L/R = 15ms with 2 poles in series			
	=24V	A	25
	48V	A	22
	75V	A	20
	110V	A	15
	220V	A	3
IEC max current I _e in DC3-DC5 with L/R = 15ms with 3 poles in series			
	=24V	A	30
	48V	A	28
	75V	A	28
	110V	A	20
	220V	A	23
IEC max current I _e in DC3-DC5 with L/R = 15ms with 4 poles in series			
	=24V	A	–
	48V	A	–
	75V	A	–
	110V	A	–
	220V	A	–
Short-time allowable current for 10s (IEC/EN60947-1)		A	320
Protection fuse			
	gG (IEC)	A	63
	aM (IEC)	A	32
Making capacity (RMS value)		A	320
Breaking capacity at voltage			
	440V	A	256
	500V	A	240
	690V	A	192
Resistance per pole (average value)		m?	2
Power dissipation per pole (average value)			
	I _{th}	W	6
	AC3	W	2
Tightening torque for terminals			
	min	Nm	2.5
	max	Nm	3
	min	I _{bin}	1.8
	max	I _{bin}	2.2
Tightening torque for coil terminal			
	min	Nm	0.8
	max	Nm	1
	min	I _{bin}	0.8

		max	I _{bin}	0.74
Max number of wires simultaneously connectable			Nr.	2
Conductor section	AWG/Kcmil	max		6
Flexible w/o lug conductor section		min	mm ²	2.5
		max	mm ²	16
Flexible c/w lug conductor section		min	mm ²	1
		max	mm ²	10
Flexible with insulated spade lug conductor section		min	mm ²	1
		max	mm ²	10
Power terminal protection according to IEC/EN 60529				IP20 when wired
Mechanical features				
Operating position		normal allowable		Vertical plan ±30°
Fixing				Screw / DIN rail 35mm
Weight			g	422
Conductor section	AWG/kcmil conductor section	max		6
Operations				
Mechanical life			cycles	20000000
Electrical life			cycles	1600000
Safety related data				
Performance level B10d according to EN/ISO 13489-1		rated load	cycles	1600000
		mechanical load	cycles	20000000
Mirror contacts according to IEC/EN 60947-4-1				yes
EMC compatibility				yes
AC coil operating				
Rated AC voltage at 60Hz			V	24
AC operating voltage	of 60Hz coil powered at 60Hz			
	pick-up	min	%Us	80
		max	%Us	110
	drop-out	min	%Us	20
		max	%Us	55
AC average coil consumption at 20°C	of 60Hz coil powered at 60Hz			
		in-rush	VA	75
		holding	VA	9
Dissipation at holding =20°C 50Hz			W	2.5
Max cycles frequency				
Mechanical operation			cycles/h	3600
Operating times				
Average time for U _s control				

in AC

Closing NO	min	ms	8
	max	ms	24
Opening NO	min	ms	5
	max	ms	15
Closing NC	min	ms	9
	max	ms	20
Opening NC	min	ms	9
	max	ms	17

UL technical data

Full-load current (FLA) for three-phase AC motor

at 480V	A	27
at 600V	A	27

Yielded mechanical performance

for single-phase AC motor

110/120V	HP	3
230V	HP	7.5

for three-phase AC motor

200/208V	HP	10
220/230V	HP	10
460/480V	HP	20
575/600V	HP	25

General USE

Contactor

AC current	A	55
------------	---	----

Short-circuit protection fuse, 600V

High fault

Short circuit current	kA	100
Fuse rating	A	100
Fuse class		J

Standard fault

Short circuit current	kA	5
Fuse rating	A	125

Ambient conditions

Temperature

Operating temperature

min	°C	-50
max	°C	70

Storage temperature

min	°C	-60
max	°C	80

Max altitude

m	3000
---	------

Resistance & Protection

Pollution degree

3

Dimensions

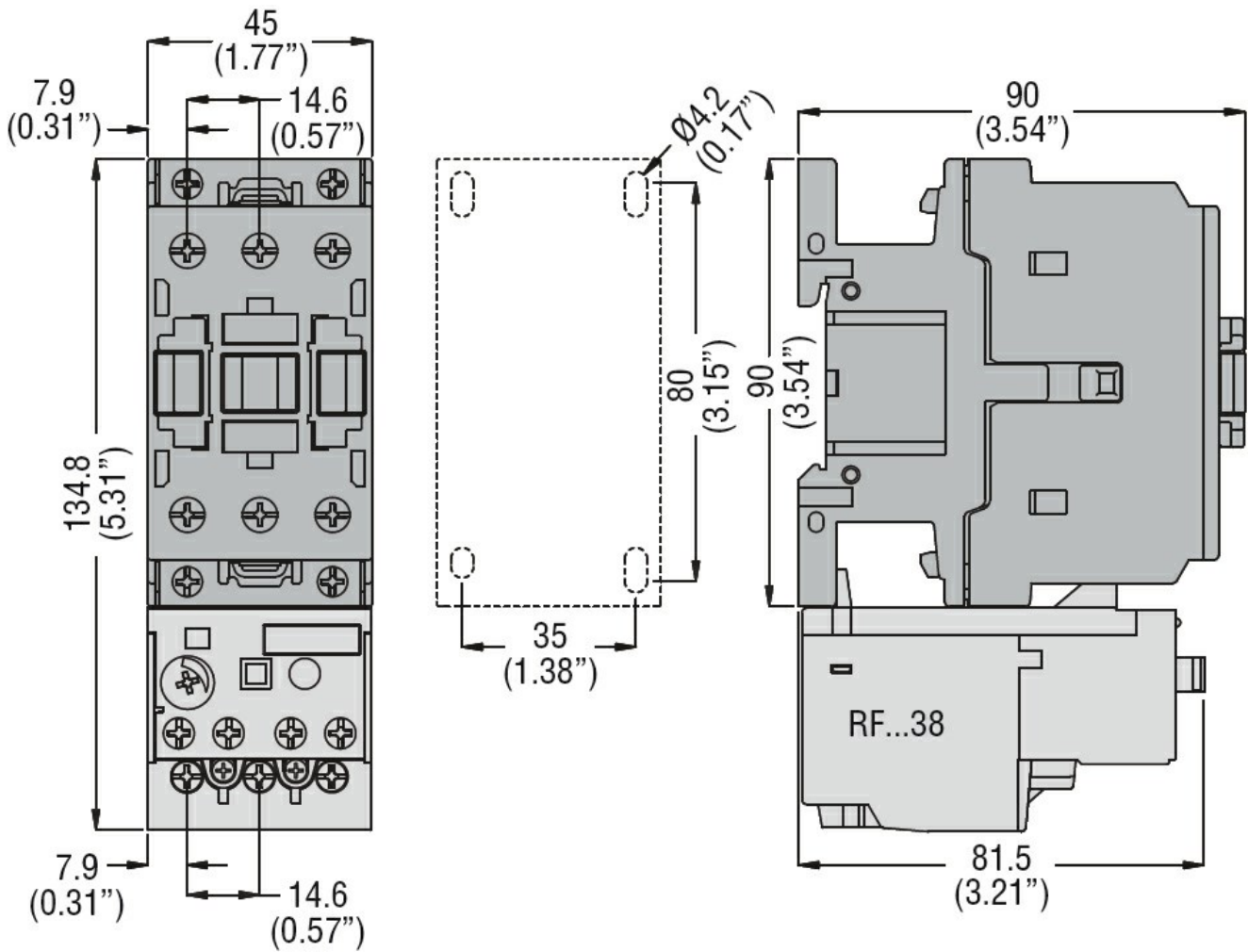

Wiring diagrams

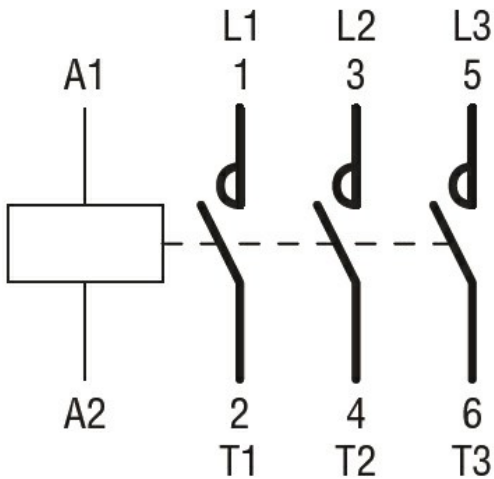

Certifications and compliance

Compliance

CSA C22.2 n° 60947-1

CSA C22.2 n° 60947-4-1

IEC/EN/BS 60947-1

IEC/EN/BS 60947-4-1

UL 60947-1

UL 60947-4-1

Certificates

CCC

cULus

EAC

ETIM classification

ETIM 8.0

EC000066 -
Power contactor,
AC switching